

# Data Sheet



Article number: 7806080913920250

Description: BEGE flangeencoder for 56B14  
MN80-9-1392-3 (25m) 5-24V

## Measures

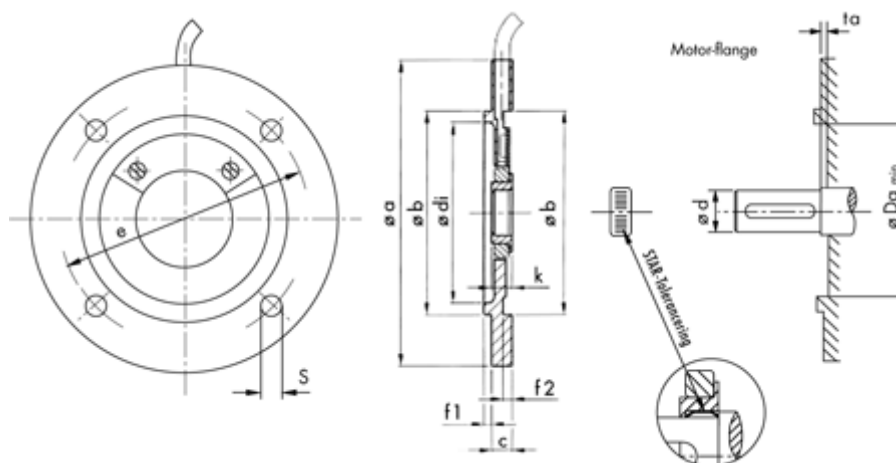

$a = 80$	$f2 = 3.0$
$b = 50$	$k = 7$
$c = 7$	$s = 6$
$d = 9$	$ta = 2$
$Da = 43$	
$di = 44$	
$e = 65$	
$f1 = 2.5$	